

Clariflo®



SANDER/POLISHER

MODEL NO: CP185

PART NO: 6462106

OPERATING & MAINTENANCE INSTRUCTIONS



UK
CA | CE

ORIGINAL INSTRUCTIONS=

GC11/22 - rev 7

INTRODUCTION

Thank you for purchasing this CLARKE Sander/Polisher.

Before attempting to use this product, please read this manual thoroughly and follow the instructions carefully. In doing so you will ensure the safety of yourself and that of others around you, and you can look forward to your purchase giving you long and satisfactory service.

Your Sander/Polisher has been designed to give long and trouble free service. If, however, having followed the instructions in this booklet carefully, you encounter problems, take the unit to your local CLARKE dealer.

GUARANTEE

This product is guaranteed against faulty manufacture for a period of 12 months from the date of purchase. Please keep your receipt which will be required as proof of purchase.

This guarantee is invalid if the product is found to have been abused or tampered with in any way, or not used for the purpose for which it was intended.

Faulty goods should be returned to their place of purchase, no product can be returned to us without prior permission.

This guarantee does not effect your statutory rights.

ENVIRONMENTAL RECYCLING POLICY



Through purchase of this product, the customer is taking on the obligation to deal with the WEEE in accordance with the WEEE regulations in relation to the treatment, recycling & recovery and environmentally sound disposal of the WEEE.

In effect, this means that this product must not be disposed of with general household waste. It must be disposed of according to the laws governing Waste Electrical and Electronic Equipment (WEEE) at a recognised disposal facility.

TABLE OF CONTENTS

INTRODUCTION	2
GUARANTEE	2
ENVIRONMENTAL PROTECTION	2
TABLE OF CONTENTS	3
GENERAL SAFETY RULES	4
ELECTRICAL CONNECTIONS	6
OVERVIEW	7
BEFORE USE	8
OPERATION	9
MAINTENANCE	10
FAULT FINDING	11
SPECIFICATION	12
CONSUMABLE SPARE PARTS	13
COMPONENT PARTS	14
DECLARATIONS OF CONFORMITY	15

GENERAL SAFETY RULES



CAUTION: FAILURE TO FOLLOW THESE PRECAUTIONS COULD RESULT IN PERSONAL INJURY, AND/OR DAMAGE TO PROPERTY.

WORK ENVIRONMENT

1. **Keep the work area clean and well lit.** Cluttered and dark areas invite accidents.
2. **Do not operate power tools in explosive atmospheres such as in the presence of flammable liquids, gasses or dust.** Power tools create sparks which may ignite dust or fumes.
3. **Keep children and bystanders away while operating a power tool.** Distractions can cause you to lose control.

ELECTRICAL SAFETY

1. **Power tools must match the power outlet. Never modify the plug in any way. Do not use adaptor plugs with earthed (grounded) power tools.** Correct plugs and outlets will reduce the risk of electric shock.
2. **Do not expose power tools to rain or wet conditions.** Any water entering power tools will increase the risk of electric shock.
3. **Do not abuse the electrical cable. Never use the cord for pulling or unplugging the power tool. Keep the cable away from sources of heat, oil, sharp edges or moving parts.** Damaged or tangled cables increase the risk of electric shock.
4. **When operating a power tool outdoors, use an extension cable suitable for outdoor use.** Using the correct cable reduces the risk of electric shock.

PERSONAL SAFETY

1. **Stay alert, watch what you are doing and use common sense when you are operating a power tool.** Do not operate a power tool when you are tired, ill or under the influence of alcohol, drugs or medication.
2. **Wear personal protective equipment including eye protection.** Safety equipment such as a dust mask, non-skid shoes or hearing protection used for appropriate conditions will reduce personal injuries. Use a face or dust mask if operation is particularly dusty. Wear ear protectors/defenders as the noise level of this machine can exceed 85dB (A). If working at floor level, always wear knee pads.

3. **Do not over-reach.** Keep your proper footing and balance at all times. This enables better control of the power tool in unexpected situations.
4. **Avoid accidental starting of the machine.** Ensure the switch is in the off position and the locking button disengaged before plugging the machine in to the power supply. Carrying power tools around with your finger on the trigger or plugging in power tools that are switched on invites accidents.
5. **Dress properly.** Do not wear loose clothing or jewellery which may get caught in moving parts. Wear protective hair covering to contain long hair. For best footing, wear rubber soled footwear. Keep floor clear of oil, scrap wood, etc.
6. Concentrate on the job in hand, no matter how trivial it may seem. Be aware that accidents are caused by carelessness due to familiarity.
7. Switch the machine OFF immediately after the task is completed.

POWER TOOL USE AND CARE

1. **Do not force the machine.** Use the correct power tool for your application. It will do a better and safer job at the rate for which it was designed.
2. **Do not use the power tool if the switch does not turn it on and off.** Any power tool that cannot be controlled with the switch is dangerous and must be repaired.
3. **Disconnect the power tool from the power supply before making any adjustments, changing accessories, or storing the tool.** These measures will reduce the risk of the power tool starting accidentally.
4. **Store power tools out of the reach of children and do not allow persons unfamiliar with these instructions to operate the power tool.** Power tools are potentially dangerous in the hands of untrained users.
5. **Maintain power tools in top condition.** Keep tools/ machines clean for the best and safest performance. Check for misalignment or binding of moving parts, broken parts, or any condition that may affect the power tool's operation. If damaged, have the power tool repaired before use. Many accidents are caused by poorly maintained power tools.
6. **Use recommended accessories.** The use of improper accessories could be hazardous.
7. **Machine cleanliness.** Do not allow the ventilation slots in the machine to become blocked with dust.
8. **Check the power tool for damage before using the machine.** Any damaged part should be inspected to ensure that it will operate properly and perform its intended function. Check for alignment of moving parts, breakage of parts, mountings, and any other condition that may affect the machine's operation. Any damage should be properly repaired or the part replaced. If in doubt, **DO NOT** use the machine. Consult your local dealer

ELECTRICAL CONNECTIONS



WARNING! Read these electrical safety instructions thoroughly before connecting the product to the mains supply.

Before switching the product on, make sure that the voltage of your electricity supply is the same as that indicated on the rating plate. This product is designed to operate on 230VAC 50Hz. Connecting it to any other power source may cause damage.

This product may be fitted with a non-rewireable plug. If it is necessary to change the fuse in the plug, the fuse cover must be refitted. If the fuse cover becomes lost or damaged, the plug must not be used until a suitable replacement is obtained.

If the plug has to be changed because it is not suitable for your socket, or due to damage, it should be cut off and a replacement fitted, following the wiring instructions shown below. The old plug must be disposed of safely, as insertion into a mains socket could cause an electrical hazard.



**WARNING! The wires in the power cable of this product are coloured in accordance with the following code:
Blue = Neutral Brown = Live**

If the colours of the wires in the power cable of this product do not correspond with the markings on the terminals of your plug, proceed as follows.

- The **Blue** wire must be connected to the terminal marked **N**.
- The **Brown** wire must be connected to the terminal marked **L**.

Plug must be BS1363/A approved.

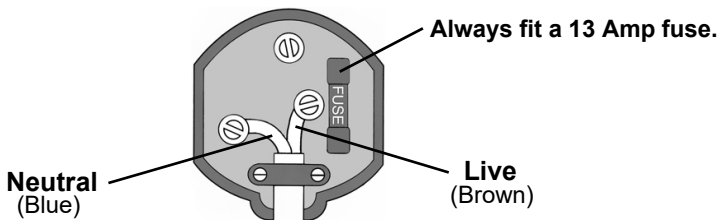

Ensure that the outer sheath of the cable is firmly held by the clamp

We strongly recommend that this machine is connected to the mains supply via a Residual Current Device (RCD)

If in any doubt, consult a qualified electrician. DO NOT attempt any repairs yourself.



This symbol indicates that this is a Class II product, and does not require an earth connection.

OVERVIEW

When unpacking, check for damage or shortages etc. Any found should be reported to your CLARKE dealer where the appliance was originally purchased. This CP185 sander/polisher is supplied with the following components:

- 1 x 'D' Handle
- 2 x Handle Fixing Bolts
- 2 x Washers
- 1 x 6 mm Hexagon Key
- 1 x 180 mm Backing Pad
- 1 x Wool Polishing Bonnet

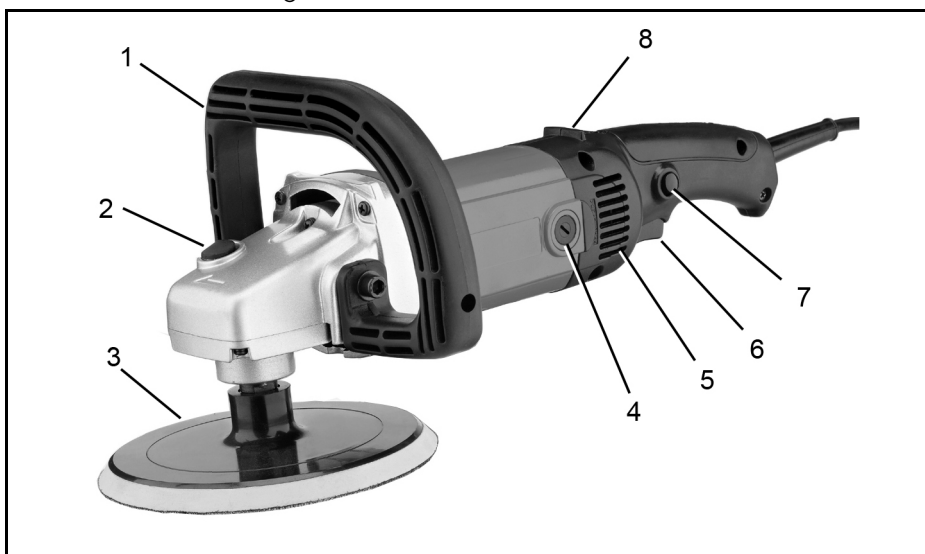

NO	DESCRIPTION	NO	DESCRIPTION
1	'D' Handle	5	Air Vent
2	Spindle Lock Button	6	Trigger
3	Backing Pad	7	Trigger Lock Button
4	Brush Holder Cap	8	Speed Controller

BEFORE USE



WARNING: MAKE SURE THAT THE TOOL IS SWITCHED OFF AND UNPLUGGED FROM THE MAINS SUPPLY BEFORE FITTING OR REMOVING THE 'D' HANDLE OR BACKING PAD.

FITTING THE 'D' HANDLE

1. Slot the 'D' handle onto the body of the tool, locating the lugs into the recesses in the tool body.

NOTE: the handle is recessed to fit onto the tool in one position only, and is not adjustable, other than for left or right handed use.

2. When the handle is in position, secure in position with two allen screws, supplied, tighten using 6 mm Hex key, DO NOT overtighten



FITTING THE BACKING PAD

1. Screw the backing disc onto the spindle.
2. Press and hold the spindle lock button and tighten the pad hand tight in a clockwise direction.
 - Either the polishing bonnet or a sanding disc can be fitted.

IMPORTANT: Never press the spindle lock button while the motor is running. Failure to observe this instruction may cause internal damage or could lead to personal injury

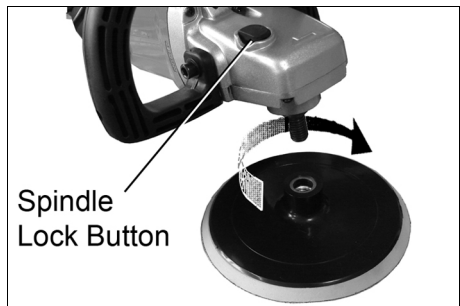

OPERATION

1. Whether polishing or sanding, always ensure the workpiece is securely fixed, i.e. clamped to a workbench or secured in a vice.
2. When working on car bodywork, the vibration may cause any items left on the car bonnet, boot or roof, to fall onto the rotating disc and be thrown, leading to injury to yourself or others in the work vicinity. Always keep the work area tidy.
3. Hold the sander/polisher firmly with both hands and switch on. The motor will then run. Press and hold the trigger lock button whilst holding the trigger in and the tool will run continuously. To release the button, squeeze the trigger, then release and the motor will stop.
4. Adjust the speed control to the desired working speed.
5. Slowly apply the sander/polisher to the workpiece and proceed to sand or polish. Move the disc across the work applying a light even pressure.



WARNING: ENSURE THAT THE WORKING POSITION ADOPTED DOES NOT CAUSE OPERATOR FATIGUE WHICH MAY LEAD TO LOSS OF CONTROL

- If it is necessary to change the speed, always lift the disc from the work surface, adjust the speed control to the required speed then reapply to the work surface and continue as before.
6. On completion, lift the sander/polisher from the work surface and release the trigger



WARNING: THE DISC WILL CONTINUE TO ROTATE FOR A FEW SECONDS AFTER THE TRIGGER HAS BEEN RELEASED.

7. Ensure the motor has come to a complete stop before setting the tool down on the workbench etc. Failure to do so can cause the tool to be thrown, resulting in damage to the tool or personal injury.

MAINTENANCE

Before commencing any maintenance procedures, always ensure the sander/polisher is isolated from the electrical supply by switching off and removing the plug from the power socket.

BEFORE USE

1. Always inspect the tool before use and ensure it is in top condition.
2. Ensure all fixing screws remain tight to ensure the tool is in safe working condition.
3. Inspect the power cable to ensure it is sound and free from cracks or bare wires etc.

CLEANING

1. Ensure all air ventilation slots are clear, (Use compressed air to clean the tool if possible. Always wear protective goggles when cleaning with compressed air).
2. Clean the exterior of the tool with a soft cleaning cloth. Never use any chemicals or harsh abrasives. Avoid using solvents when cleaning plastic parts, which may be susceptible to damage from various types of commercial solvents.

GENERAL MAINTENANCE

1. Occasionally remove and inspect the motor brushes and replace if necessary.
 - When removing brushes, note which way round they are. The brushes must be returned exactly as they are removed, DO NOT swap over positions etc.
2. Never allow the brushes to wear more than two thirds of their original length, (new brushes are approximately 13 mm long), fit new brushes when or before they are worn down to 5 mm.
 - All bearings etc, in this tool are lubricated with a sufficient amount of high grade lubricant for the tools lifetime under normal operating conditions, therefore no further lubrication is necessary.
 - Refer to your CLARKE dealer if internal maintenance is required.

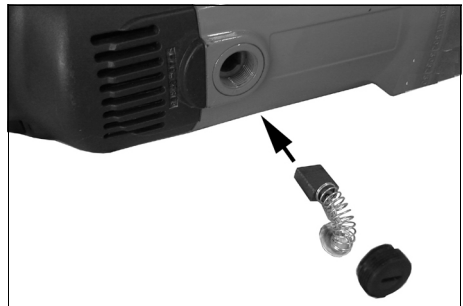

FAULTFINDING

Problem	Possible Cause	Remedy
Tool will not operate	No power supply	Check supply and rectify as necessary.
	Faulty Switch	Consult your Clarke dealer
	Fuse blown	Consult your Clarke dealer if necessary.
	Faulty motor	Consult your Clarke dealer
Motor runs but pad does not rotate	Pad fastening not engaged.	Press button and engage pad.
	Drive gear broken.	Consult your Clarke dealer
Heavy internal sparking	Faulty motor.	Consult your Clarke dealer
Motor becomes hot	Unduly heavy use.	Reduce the force applied to the tool. Let the tool do the work.
	Air vents have become blocked.	Clean out the air vents using compressed air or clean with a dry cloth.
	Low supply voltage.	Ensure supply voltage is correct. If an extension cable is used, ensure it is of the correct rating and is fully unwound.
Excessive vibration	Disc no mounted correctly	Check and rectify.
	Machine bearings worn.	Consult your Clarke dealer

SPECIFICATIONS

Item	Specification
Dimensions (L x W x H)	420 x 190 x 180 mm
Weight	3.7 kg
Backing pad type	Polymer with 'hook & loop' system
Disc Diameter	180 mm
Operating voltage & Frequency	230 V 50 Hz
Fuse Rating	13 A
Motor Power	1200 W
No Load Speed	600-3000 rpm
Sound Pressure Level (LpA dB)	LWA 85.0 dB(A)
Sound Power Level (LwA dB)	LWA 96 db (A)
Vibration (front handle)	Less than 2.5 m ²

Please note that the details and specifications contained herein, are correct at the time of going to print. However, CLARKE International reserve the right to change specifications at any time without prior notice.

CONSUMABLE SPARE PARTS

Replacement bonnets and abrasive discs are available from your CLARKE dealer.

The Sander/Polisher Accessory Kit - CPK180 (Part No 3051995) includes:



- 1 x Foam Polishing Sponge
- 1 x Foam Rubber Backing Pad
- 1 x Rubber Backing Pad
- 1 x Synthetic Fleece Polishing Bonnet
- 1 x Wool Fleece Polishing Bonnet
- 3 x Sanding Discs (Grit 40, 60, 80)



PARTS LIST & DIAGRAM

No	Description
1	Support Ring
2	Bearing
3	Bearing Cover
4	Motor Rotor Assembly
5	Screw M8 x 20
6	Washer
7	Side Handle
8	Bearing Retainer
9	Bearing 6201
10	Front Gear Housing
11	Screw st4.8 x 35
12	Stop Cover
13	Spring
14	Screw M5 x 16
15	Screw M5 x 12
16	Stop Pin
17	Bearing 0810
18	Circlip
19	Spur Gear
20	Circlip
21	Packing Gland
22	Screw M4 x 16
23	Dust Cover

No	Description
24	Disc Spindle
25	Polishing Disc
26	Woodruff Key
27	Carbon Brush Cover
28	Carbon Brush
29	Carbon Brush Holder
30	Nameplate
31	Motor Stator
32	Screw st4.8 x 70
33	Main Housing
34	Label
35	Rear Housing (R/H)
36	Cable Entry
37	Power Cable
38	Cable Clamp
39	Screw st4.8 x 18
40	Rear Housing (L/H)
41	Trigger Assembly
42	Rivet 2 x 10
43	Spring
44	Speed Controller
45	Nameplate

DECLARATIONS OF CONFORMITY

 <p>Clarke INTERNATIONAL Hennell Street, Epping, Essex CM10 4LG</p>	<p align="center">DECLARATION OF CONFORMITY</p> <p align="center">This is an important document and should be retained.</p> <p>We hereby declare that this product(s) complies with the following statutory requirements(s):</p> <p><i>Electromagnetic Compatibility Regulations 2016</i> <i>Supply of Machinery (Safety) Regulations 2008</i> <i>The Restriction of the Use of Certain Hazardous Substances in Electrical and Electronic Equipment Regulations 2012</i></p> <p>The following standards have been applied to the product(s):</p> <p>EN 55014-1:2017, EN 55014-2:2015, EN IEC 61000-3-2:2018, EN 61000-3-3:2013 + A1, EN 60745-1:2009 + A11, EN 60745-2:2011 + A2 + A11 + A12 + A13, IEC 62321-1:2013, IEC 62321-2:2013, IEC 62321-3-1:2013, IEC 62321-4:2013 + AMD1:2017 CSV, IEC 62321-5:2013, IEC 62321-6:2015, IEC 62321-7-1:2015, IEC 62321-7-2:2017, IEC 62321-8:2017, ISO 17075:2017.</p> <p>The technical documentation required to demonstrate that the product(s) meet(s) the requirement(s) of the aforementioned legislation has been compiled and is available for inspection by the relevant enforcement authorities.</p>	<p align="center">The UKCA mark was first applied in: 2022</p> <p>Product Description: 1200W Sander & Polisher Model number(s): CP185 Serial / batch Number: N/A Date of Issue: 20/10/2022</p> <p>Signed: </p> <p align="right">J.A. Clarke Director</p>	<p align="right">Page 1 of 1</p> <p align="right">CP185 UKCA, Clarke DOC 102022</p>
---	--	--	---

 <p>Clarke INTERNATIONAL Fitzwilliam Hall, Fitzwilliam Place, Dublin 2</p>	<p align="center">DECLARATION OF CONFORMITY</p> <p align="center">This is an important document and should be retained.</p> <p>We hereby declare that this product(s) complies with the following directive(s):</p> <p>2014/30/EU <i>Electromagnetic Compatibility Directive</i> 2006/42/EC <i>Machinery Directive</i> 2011/65/EU <i>Restriction of the Use of Certain Hazardous Substances in Electrical & Electronic Equipment (RoHS) Directive</i></p> <p>The following standards have been applied to the product(s):</p> <p>EN 55014-1:2017, EN 55014-2:2015, EN IEC 61000-3-2:2019, EN 61000-3-3:2013 + A1, EN 60745-1:2009 + A11, EN 60745-2:2011 + A2 + A11 + A12 + A13, IEC 62321-1:2013, IEC 62321-2:2013, IEC 62321-3-1:2013, IEC 62321-4:2013 + AMD1:2017 CSV, IEC 62321-5:2013, IEC 62321-6:2015, IEC 62321-7-1:2015, IEC 62321-7-2:2017, IEC 62321-8:2017, ISO 17075:2017.</p> <p>The technical documentation required to demonstrate that the product(s) meet(s) the requirement(s) of the aforementioned directive(s) has been compiled and is available for inspection by the relevant enforcement authorities.</p>	<p align="center">The CE mark was first applied in: 2007</p> <p>Product Description: 1200W Sander & Polisher Model number(s): CP185 Serial / batch Number: N/A Date of Issue: 20/10/2022</p> <p>Signed: </p> <p align="right">J.A. Clarke Director</p>	<p align="right">Page 1 of 1</p> <p align="right">CP185 CE Clarke DOC 102022</p>
--	--	--	--

A SELECTION FROM THE VAST RANGE OF

Clarke®

QUALITY PRODUCTS



AIR COMPRESSORS

From DIY to industrial, Plus air tools, spray guns and accessories.

GENERATORS

Prime duty or emergency standby for business, home and leisure.

POWER WASHERS

Hot and cold, electric and engine driven - we have what you need

WELDERS

Mig, Arc, Tig and Spot. From DIY to auto/industrial.

METALWORKING

Drills, grinders and saws for DIY and professional use.

WOODWORKING

Saws, sanders, lathes, mortisers and dust extraction.

HYDRAULICS

Cranes, body repair kits, transmission jacks for all types of workshop use.

WATER PUMPS

Submersible, electric and engine driven for DIY, agriculture and industry.

POWER TOOLS

Angle grinders, cordless drill sets, saws and sanders.

STARTERS/CHARGERS

All sizes for car and commercial use.

PARTS & SERVICE: 0208 988 7400

Parts Enquiries

Parts@clarkeinternational.com

Servicing & Technical Enquiries

Service@clarkeinternational.com

SALES: UK 01992 565333 or Export 00 44 (0)1992 565335

Clarke INTERNATIONAL Hemnall Street, Epping, Essex CM16 4LG
www.clarkeinternational.com